

ACURA EMBEDDED SYSTEMS INC.

Rugged Panel PC AcuPanel 15 User Manual Revision 1.5



Acura Embedded Systems Inc.
Published Oct 29 2014

Contents

Chapter 1: AcuPanel 15 Overview

Specifications.....	2
Knowing AcuPanel 15.....	4
Rear Top.....	4
Rear Bottom	5
Rear Panel of AcuPanel15.....	6
Mechanical Dimensions.....	7

Chapter 2: Power,PS/2 Port and Panel Mounting

12V-30V DC Power Input	8
PS/2 Keyboard/Mouse Port	8
Plugging the DC power Cable.....	9
Panel Mounting.....	9

Chapter 3: BIOS Setup

About BIOS Setup	11
Default Configuration	12
Entering Setup	12
Legends.....	13
BIOS Setup Utility.....	14
Main.....	14
Advanced.....	15
IDE Configuration	15
Intel IGD Configuration.....	16
Save & Exit.....	17

Chapter 1: AcuPanel15 Overview



Key Features

- . 4:3 15" SXGA Fanless LED Panel Computer
- . Intel® Atom™ D2550, Dual Core, Low Consumption CPU
- . Flush Panel by 5-wire Touch Screen
- . Dual GbE/ 2nd display-VGA/ Line-in/ Line-out/ Mic-in/ PS2 KB/MS
- . USB x4/ 2x mini-PCIe sockets/ 1x CFast/ 2x RS232/ 422/ 485

- . Optional LTE-4G / Wi-Fi Module / 2.5"HDD / 2x COMs / GPIO / DIO
- . DDR3 1GB / 2.5" HDD Bracket
- . IP65 Compliant Front Panel
- . Mounting Support: Panel/ Wall/ Stand/ VESA 100mm x 100mm
- . Wide Range Power Input 12V~ 30V DC

Specifications

Panel

- . LED Size: 15", 4:3
- . Resolution: SXGA 1280x1024
- . Luminance: 350cd/m2
- . Contrast ratio: 1000
- . LCD color: 16.7M
- . Viewing Angle: 80(U), 80(D), 85(L), 85(R)
- . Backlight: LED

Touch Screen

- . 5-wire resistive (flush panel type)
- . Light transmission: 81%
- . Interface: USB

System

- . CPU: On-board Intel® Atom™ Dual Core processor D2550, 1.86GHz, 1M L2 Cache
- . BIOS: AMI BIOS
- . System chipset: Intel® NM10 Express chipset
- . System memory: 2x 204-pin DDR3 SO-DIMM socket, 1G DDR3 (Default), support up to 4GB DDR3-800/1066, Non-ECC and un-buffered
- . Storage Device:
 - 1x external locked CFast socket
 - 1x hard drive bay: optional 1x 2.5" SATA HDD or 1x SATA DOM
- . H/W status monitor: Monitoring system temperature, and voltage
- . Expansion: 2x mini-PCIe sockets (support optional WiFi or 4G module)
- . Panel backlight control button: Increase brightness / decrease brightness / Backlight On/Off

Rear I/O

- . Ethernet: 2x RJ45
- . 2nd display VGA port: 1x DB15
- . Audio port: 1x Line out; 1x Line in; 1x MIC-in
- . USB: 4x USB 2.0
- . PS2 keyboard/ mouse
- . Power switch
- . Reset button
- . COM #1: RS232/422/485 w/RI or 5V selection
- . COM #2: RS232/422/485 w/RI or 12V selection
- . DIO w/ 2.5kv isolated:
- 4x Digital Input (Source type)
 - Input Voltage (Dry Contact): Logic 0: Close to GND
 - Logic 1: Open
 - Input Voltage: Logic 0: 3V max
 - Logic 1: +5V ~ +30V
- 4x Digital Output (Sink type)
 - Output Voltage: 3.6V ~ 5V
 - Sink current: 200 mA max. per channel
- . GPIO: 2x digital in/ 2x digital out (Optional)
- . COM #1: RS232/422/485 w/ 2.5kv isolated
- . COM #2: RS232/422/485 w/ 2.5kv isolated
- . COM #3: RS232 w/ RI or 5V selection(Optional)
- . COM #4: RS232 w/ RI or 12V selection(Optional)

Audio

- . AC97 codec: Realtek ALC886-GR
- . Audio interface: Line out/Line in/MIC-in Audio Jack

Ethernet

- . LAN chip: dual Intel® 82574L Gigabit LAN
- . Ethernet interface: 10/100/1000 Based-Tx Ethernet compatible

Mechanical & Environment

- . Color: pantone black\RAL 15 00 front bezel w/ Pantone 400C\RAL 090 80 10 metal style membrane
- . IP protection: IP65 front
- . Mounting: panel/ wall/ stand/ VESA 100mm x 100mm
- . Power input: 12V~ 30V DC
- . Power adapter: Optional AC to DC power adaptor (+12V, 60W)
- . Vibration:

- IEC 68 2-64 (w/ HDD)
- 1Grms @ sine, 5~500Hz, 1hr/axis (HDD Operating)
- 2Grms @ sine, 5~500Hz, 1hr/axis (CFast Operating)
- 2.2Grms @ random condition, 5~500Hz, 0.5hr/axis (Nonoperating)
- . Shock:
- IEC 68 2-27
- HDD: 20G@wall mount, half sine, 11ms
- . Operating temperature: -5°C to 50°C
- . Storage temperature: -20°C to 75°C
- . Operating humidity: 10%~90% relative humidity, non-condensing
- Limits to be at 90% RH at max 50°C
- . Dimension: 384.37 x 309.95 x 63.2 mm
- . Weight: 5~6.5 Kg

Certifications

- . CE approval
- . FCC Class A

Knowing AcuPanel 15

Rear Top

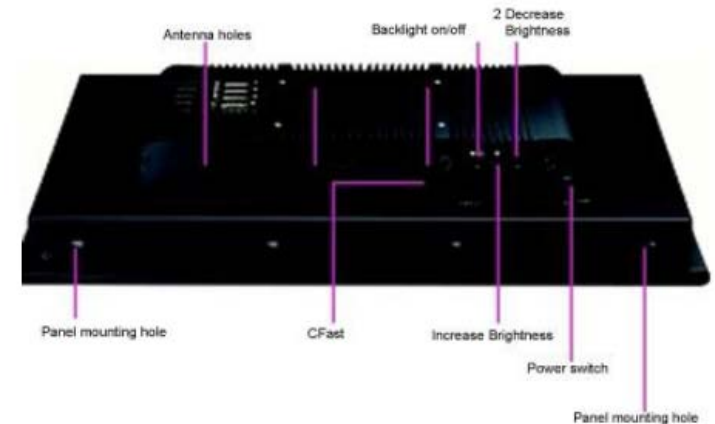

Antenna holes for optional 4G/ WiFi/ Bluetooth
 The 3 external antenna holes are used to mount and connect optional 4G/ WiFi/ Bluetooth antennas.
CFast Card Socket Used to insert a CFast card.

Power Switch Press to power-on or power-off the panel PC.

Panel Backlight Control Buttons

Backlight On/Off Press to turn-on or turn-off the display

Increase Brightness Press to increase brightness of the screen.

Decrease Brightness Press to decrease brightness of the screen.

8 brightness level available: 30%, 40%, 50%, 60%, 70%, 80%, 90% and 100%

Rear Bottom

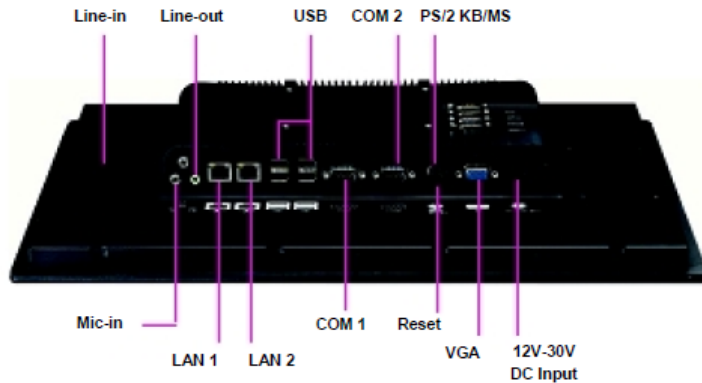

Line-in Used to connect an audio device as sound source.

Mic-in Used to connect an external microphone.

Line-out Used to connect a headphone or a speaker.

LAN 1 and LAN 2 Used to connect the system to a local area network. LAN1 supports Wake up on LAN.

USB Used to connect USB 2.0/1.1 devices.

COM 1 and COM 2 These COM ports support RS232/422/485 compatible series device by BIOS setting.

AcuPanel 15 has 2.5kV isolated protection.

PS/2 KB/MS Used to connect a PS/2 keyboard and a PS/2 mouse

Reset Button Press this button to restart the system.

VGA Used to connect an analog VGA monitor.

12V-30V DC Input Used to plug a DC power cord.

Rear (AcuPanel15)

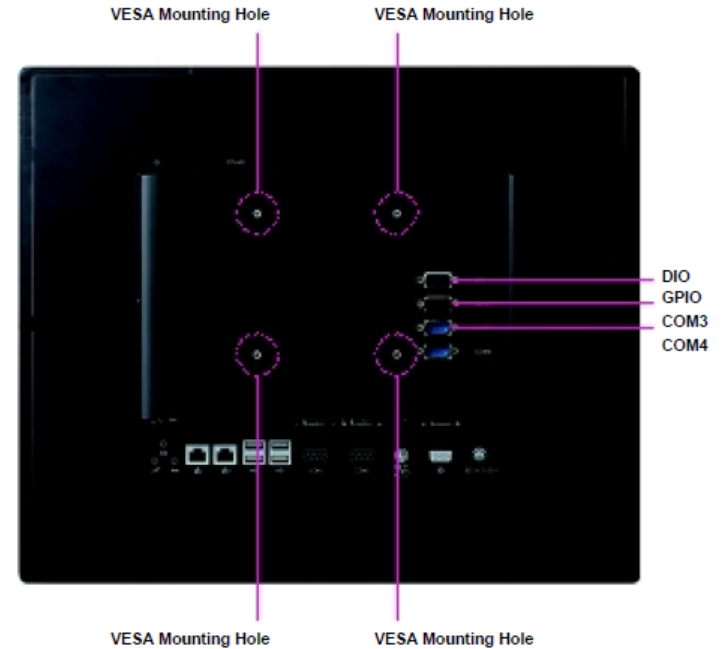

DIO (Optional)

The digital I/O connector support 4 isolated protection digital input channels and 4 isolated protection digital output channels.

Isolation voltage: 2500 VDC

DI: 4x Digital Input (Source Type)

- Input Voltage (Dry Contact) Logic 0: Close to GND ; Logic 1: Open

- Input Voltage (Wet Contact) Logic 0: 3V max. Logic 1: +5V-+30VDC

4x Digital Output (Sink Type)

- Output Voltage: Typical 24VDC, 30VDC max.

Logic 0: 0-0.6VDC Logic 1: 3.6-5VDC

- Sink Current: 200mA max. per channel

GPIO (Optional)

The GPIO connector supports 2 digital input and 2 digital output.

COM3 and COM4 (Optional)

These COM ports support RS232 compatible serial devices.

COM3 supports 5V or RI by Jumper setting.
 COM4 supports 12V or RI by Jumper setting.

VESA Mounting Holes

These are mounting holes for VESA mount (100x100mm).

Mechanical Dimensions

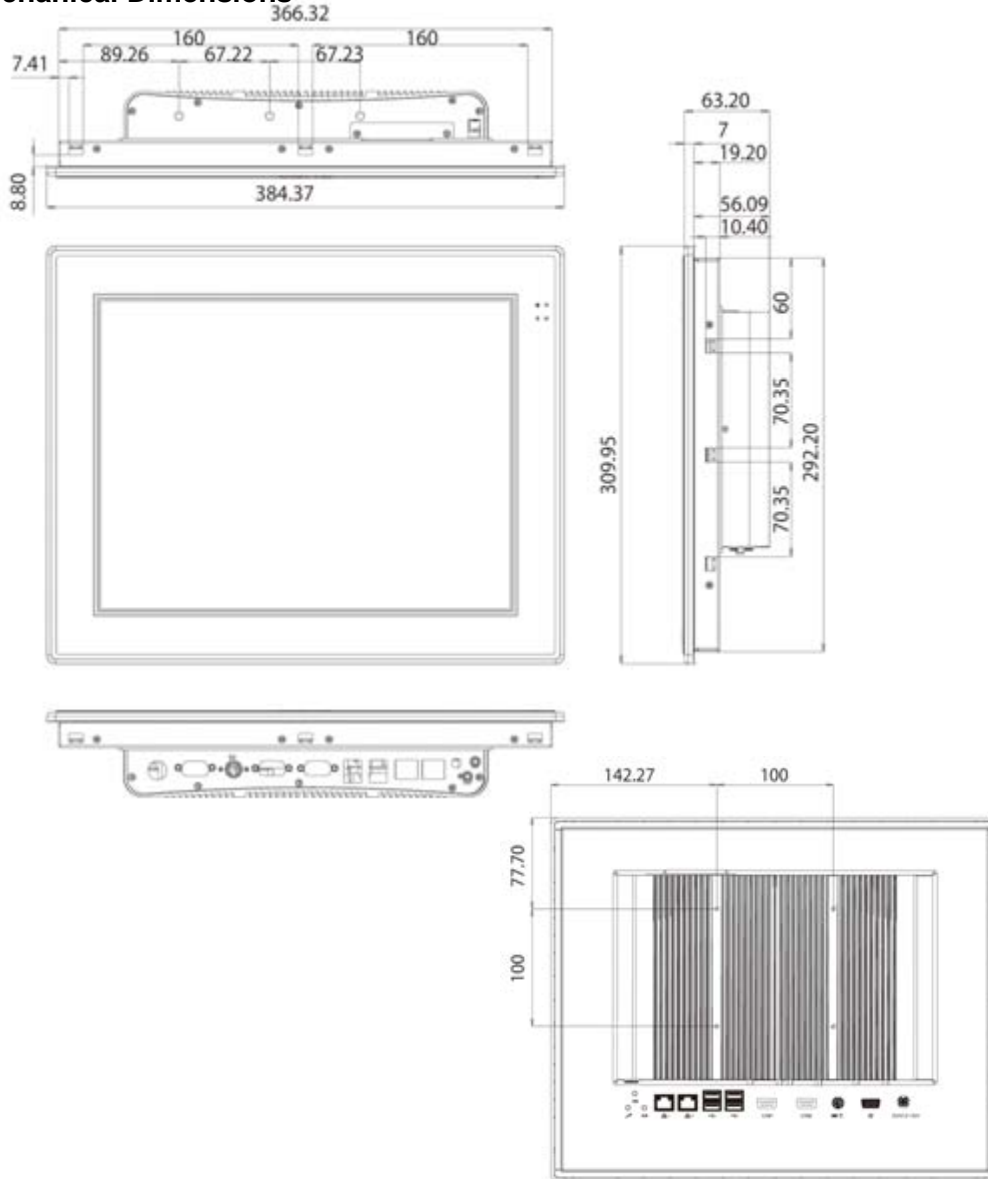

Chapter 2: Power, PS/2 Port, Cable and Panel Mounting

12V-30V DC Power Input

Connector type: DC 4-pin DIN power jack with shield

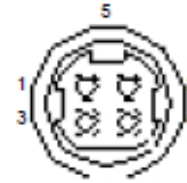

Pin	Settings
1	DC+
2	DC+
3	DC-
4	DC-
5	GND

PS/2 Keyboard/Mouse Port

Connector type: PS/2, Mini-DIN-6, 2.0mm pitch
 2x4 8-pin header, 2.54mm pitch



External Connector

Pin	Settings
1	KB_DATA
2	MS_DATA
3	GND
4	VCC5
5	KB_CLK
6	MS_CLK

Plugging the DC Power Cable

1. Plug the DC 4-pin DIN power jack (male) into the DC 4-pin DIN power jack (female) that is on the system. The table below shows the pin definition of the cable.



Color	Pin Definition
Black	GND
Red&Yellow	DC+
Blue&Black	DC-

Panel Mounting

1. Select a place on the panel where you will mount the Panel PC.
2. Cut out a shape on the panel that corresponds to the Panel PC's rear dimensions.

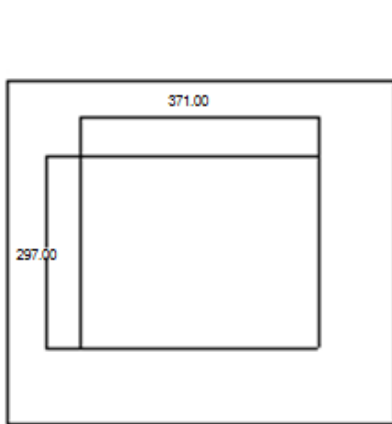

AcuPanel 15



The thickness of the panel (e.g. steel board, plank, acrylic board, wall, etc.) where you will mount the Panel PC must not exceed 6mm. If the distance between the front bezel and panel mount hole is too wide, it will not fit the panel mount kit.

3. Slide the Panel PC through the hole until it is properly fitted against the panel.

4. Position the mounting clamps along the rear edges of the Panel PC. The first and second clamps must be positioned and secured diagonally prior to mounting the rest of the clamps. Tighten the clamp's screw until it touches the panel.



CAUTION!

Do not overtighten the screws to prevent damaging the Panel PC.

Chapter 3: BIOS Setup

This chapter describes how to use the BIOS setup program for the AcuPanel 15. The BIOS screens provided in this chapter are for reference only and may change if the BIOS is updated in the future.

About BIOS Setup

The BIOS (Basic Input and Output System) Setup program is a menu driven utility that enables you to make changes to the system configuration and tailor your system to suit your individual work needs. It is a ROM-based configuration utility that displays the system's configuration status and provides you with a tool to set system parameters.

These parameters are stored in non-volatile battery-backed-up CMOS RAM that saves this information even when the power is turned off. When the system is turned back on, the system is configured with the values found in CMOS.

With easy-to-use pull down menus, you can configure such items as:

- . Hard drives, diskette drives, and peripherals
- . Video display type and display options
- . Password protection from unauthorized use
- . Power management features

The settings made in the setup program affect how the computer performs. It is important, therefore, first to try to understand all the setup options, and second, to make settings appropriate for the way you use the computer.

When to Configure the BIOS

- . This program should be executed under the following conditions:
- . When changing the system configuration
- . When a configuration error is detected by the system and you are prompted to make changes to the setup program
- . When resetting the system clock
- . When redefining the communication ports to prevent any conflicts
- . When making changes to the Power Management configuration

- . When changing the password or making other changes to the security setup

Normally, CMOS setup is needed when the system hardware is not consistent with the information contained in the CMOS RAM, whenever the CMOS RAM has lost power, or the system features need to be changed.

Default Configuration

Most of the configuration settings are either predefined according to the Load Optimal Defaults settings which are stored in the BIOS or are automatically detected and configured without requiring any actions. There are a few settings that you may need to change depending on your system configuration.

Entering Setup

When the system is powered on, the BIOS will enter the Power-On Self Test (POST) routines. These routines perform various diagnostic checks; if an error is encountered, the error will be reported in one of two different ways:







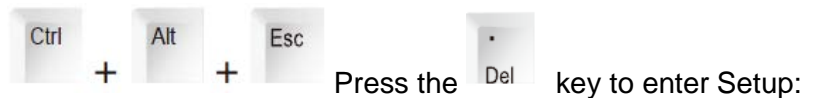



- . If the error occurs before the display device is initialized, a series of beeps will be transmitted.
- . If the error occurs after the display device is initialized, the screen will display the error message.

Powering on the computer and immediately pressing allows you to enter Setup. Another way to enter Setup is to power on the computer and wait for the following message during the POST:

TO ENTER SETUP BEFORE BOOT PRESS

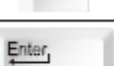

Legends

Key	Function
	Moves the highlight left or right to select a menu.
	Moves the highlight up or down between sub-menus or fields.
	Exits the BIOS Setup Utility.
	Scrolls forward through the values or options of the highlighted field.
	Scrolls backward through the values or options of the highlighted field.
	Selects a field.
	Displays General Help.
	Load previous values.
	Load optimized default values.
	Saves and exits the Setup program.
	Press <Enter> to enter the highlighted sub-menu

Scroll Bar

When a scroll bar appears to the right of the setup screen, it indicates that there are more available fields not shown on the screen. Use the up and down arrow keys to scroll through all the available fields.

Submenu

When "" appears on the left of a particular field, it indicates that a submenu which contains additional options are available for

that field. To display the submenu, move the highlight to that field and press  .

BIOS Setup Utility

Once you enter the AMI BIOS Setup Utility, the Main Menu will appear on the screen. The main menu allows you to select from several setup functions and one exit. Use arrow keys to select among the items and press  accept or enter the submenu.

Main

The Main menu is the first screen that you will see when you enter the BIOS Setup Utility.



Advanced

The Advanced menu allows you to configure your system for basic operation. Some entries are defaults required by the system board, while others, if enabled, will improve the performance of your system or let you set some features according to your preference.

Setting incorrect field values may cause the system to malfunction.

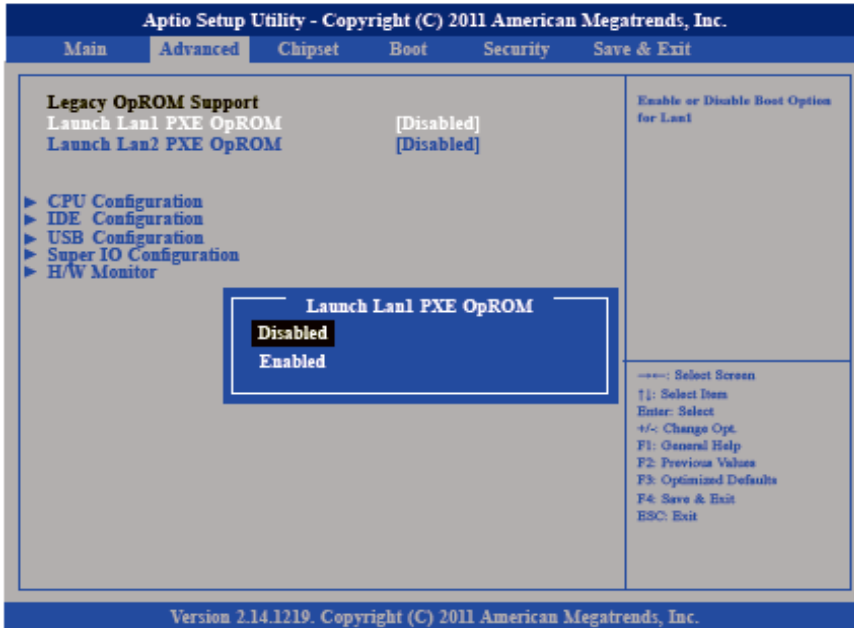

IDE Configuration

This section is used to configure the SATA as IDE or AHCI mode.

AHCI (default Setting)

This option configures the Serial ATA drives as Parallel ATA physical storage device.

This option configures the Serial ATA drives to use AHCI (Advanced Host Controller Interface). AHCI allows the storage driver to enable the advanced Serial ATA features which will increase storage performance.

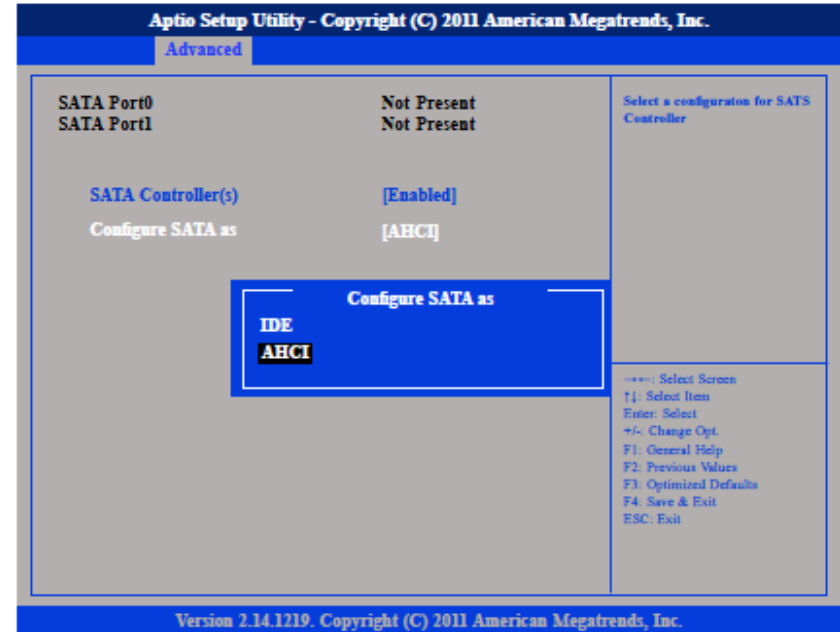

Intel® IGD Configuration

This section is used to configure the Intel® IGD Graphic configurations.

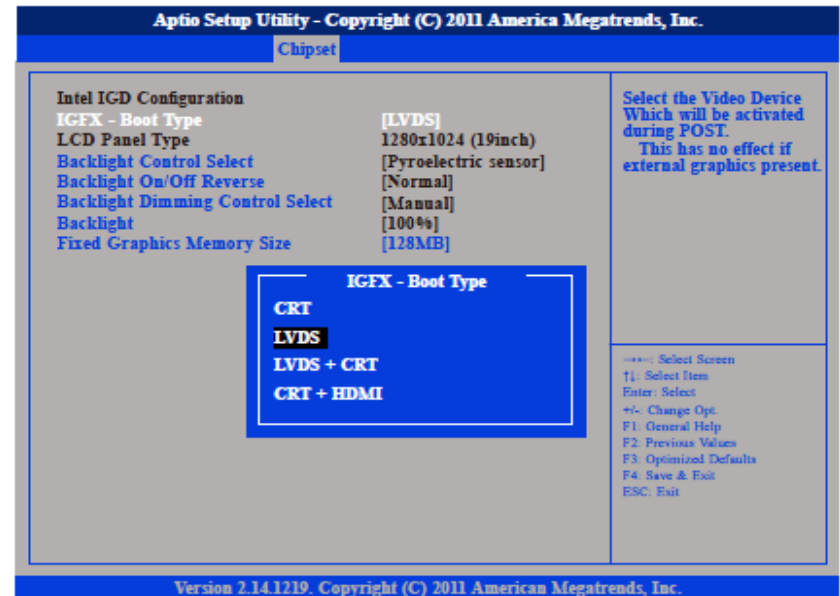

IGFX – Boot Type

This field is used to configure which video device will be activated during POST. This has no effect if external graphics present. The options are CRT, LVDS, LVDS + CRT and CRT + HDMI.

Backlight Control Select

The available options are Pyroelectric sensor and Tact Switch. The default setting is Tact Switch and the Backlight On/Off button is functional only in this mode.

Backlight On/Off Reverse

Please configure this option only when changing the panel, otherwise the display may not work.

Backlight Dimming Control Select

The options are Tact Switch, Manual and Light sensor. and the Backlight option below will be configurable. The default setting is Tact Switch and the Backlight option below will not be configurable, please use the brightness button on the panel to adjust it.

Backlight

Adjusts the brightness of the backlight.

Fixed Graphics Memory Size

This field is used to configure the memory size of the fixed graphics, the options are 128MB and 256MB.

Save & Exit

Save Changes and Reset



To save the changes and reset, select this field then press <Enter>. A dialog box will appear. Confirm by selecting Yes.

Technical Support:

contact [Salesperson](#) support@acuraembedded.com

Mailing address: **Acura Embedded Systems Inc.**

#101-17825 64 Ave, Surrey, BC V3S 1Z3, CANADA

Ph: (604) 502-9666 Fax: (604) 502-9668

Toll Free 1-866-502-9666

